



Serie

# Stilo - 60 RPT-L

## Especificaciones Técnicas

Carpintería practicable con Rotura de Puente Térmico

Cámara Europea

Junta abierta con Junta Central

Sección de Marco ..... 53 mm.

Sección de Hoja ..... 60 mm.

Galce de vidrio ..... de 10,5 a 54 mm.

Peso Máximo por : Hoja Practicable : 120 Kg.<sup>(1)</sup>

Hoja Oscilo- Batiente : 130 Kg.<sup>(1)</sup>

Hoja Oscilo- Batiente con opción Herraje Oculto

Medidas Máximas por Hoja para todas las aperturas :

1700 mm. x 2500 mm.<sup>(1)</sup>

(1) Consultar rangos de aplicación con nuestro Dpto. Técnico Comercial

## Clasificación obtenida

Permeabilidad al aire*	CLASE 4
Estanqueidad al agua*	CLASE E1050
Resistencia al viento*	CLASE C5
Transmitancia térmica**	1,6 W(m <sup>2</sup> K)
Aislamiento Acústico***	38 (-1;-5)dB

\* Ventana de 2 hojas de 1230 x 1480 mm.

\*\* Ventana de 2 hojas de 1230 x 1480 mm ; Vidrio Uv: 1,0 W(m<sup>2</sup> K)

\*\*\* Ventana de 2 hojas de 1230 x 1480 mm ; Vidrio Rw: 40 (-2,-6)dB

## Posibilidades de Apertura

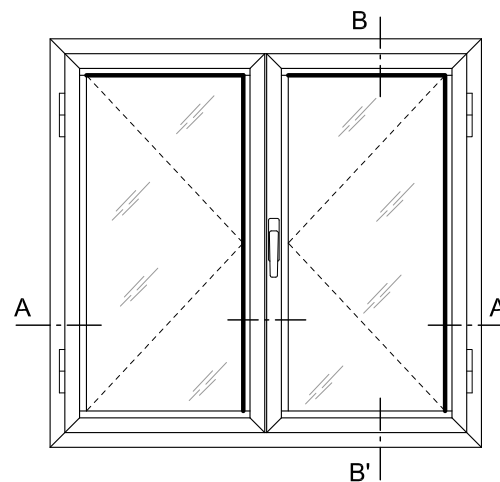
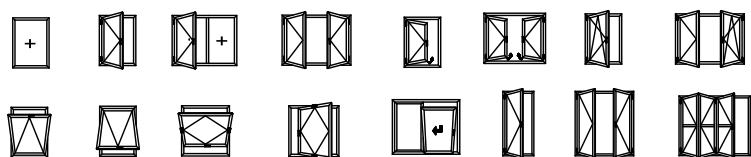

VENTANA 2 HOJAS PRACTICABLES

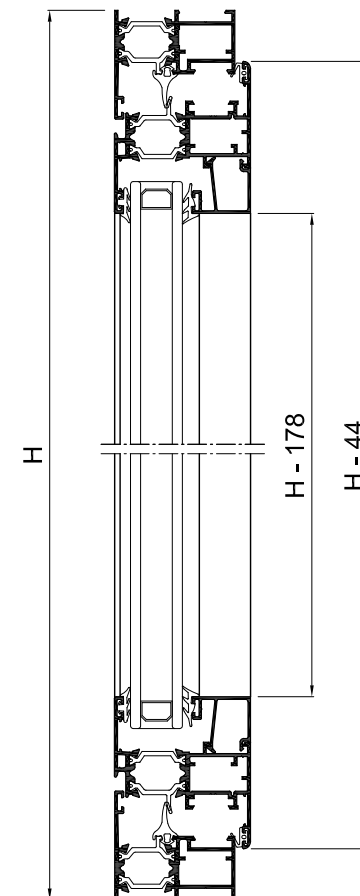

Sección B-B'

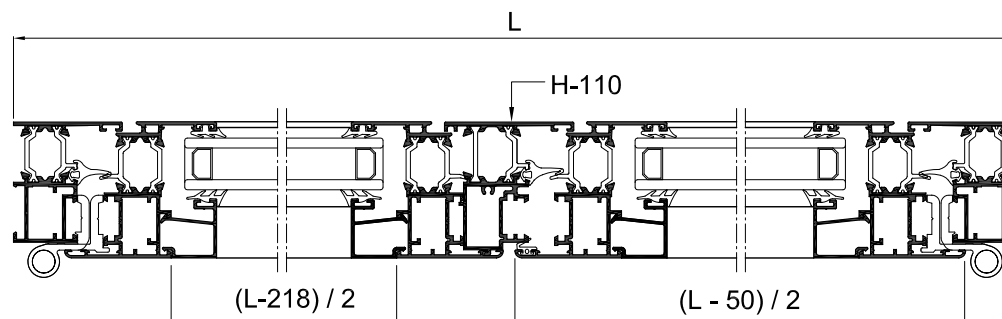

Sección A-A'

\* Tabla de Junquillos 1 (Altura 20 mm)

# Perfiles

## Stilo - 60 RPT-L

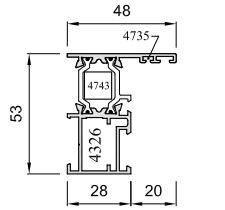

**8855L**

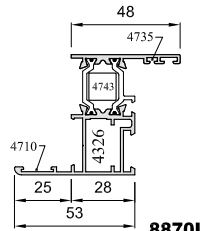

**8870L**

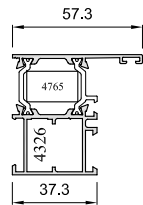

**8802L**

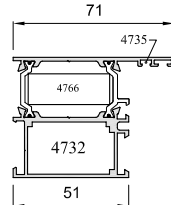

**8873L**

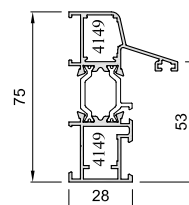

**8897L**

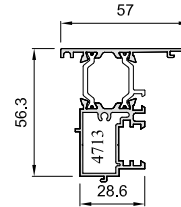

**8808L**

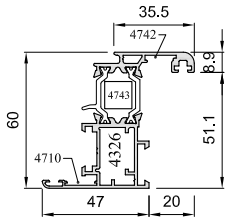

**8852L**

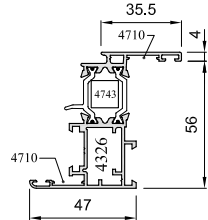

**8888L**

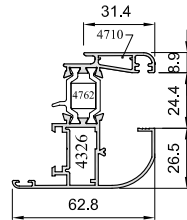

**8805L**

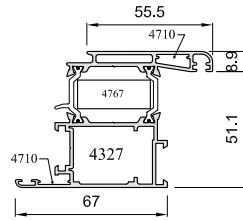

**8806L**

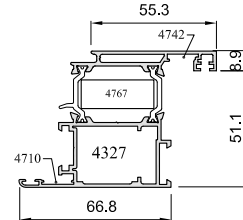

**8895L**

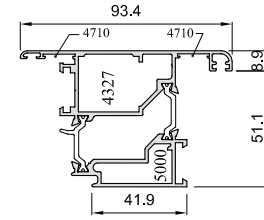

**8898L**

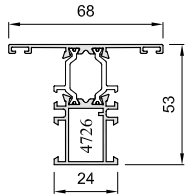

**8865L**

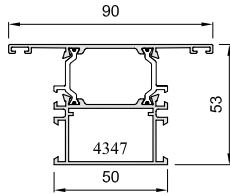

**8810L**

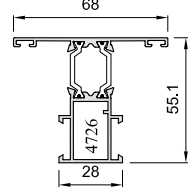

**8866L**

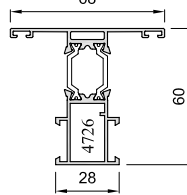

**8817L**

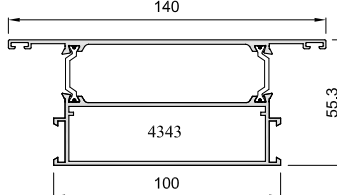

**8246L**

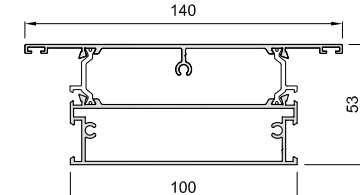

**8892L**

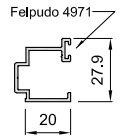

**8891**

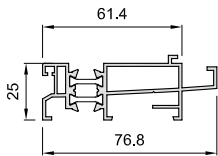

**8483M**

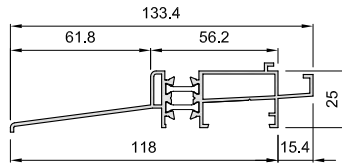

**8287M**

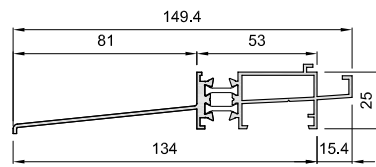

**8288M**

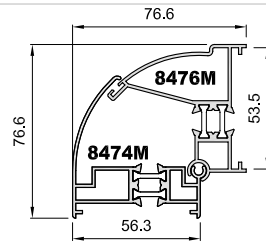

**8474M**

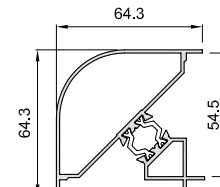

**8426M**

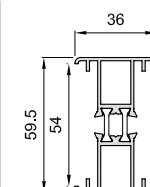

**8482M**

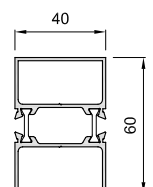

**5283M**

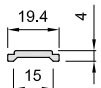

**8412**

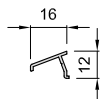

**8428**

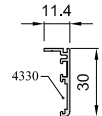

**281**  
1140

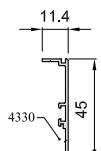

**8629**

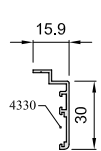

**8832**

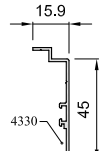

**8630**



# Accesorios Stilo - 60 RPT-L

<b>4833</b> Cremona practicable cover	<b>4834</b> Cremona os-ba Cover	<b>4725</b> Cremona Prima Os-Ba	<b>4096</b> Cremona Os-Pa con llave	<b>4398</b> Manilla recuperable	<b>4707</b> Cremona EURO c/ llave	<b>4723</b> Cremona Prima	<b>4803</b> Cremona ap. Ext. patillas Balcon.	<b>1044</b> Cierre presión (Pequeño)

<b>4024</b> Cremona EURO	<b>4019</b> Cremona EURO Os-Ba	<b>4200</b> Cremona Nova	<b>4316</b> Bisagra apertura externa	<b>4390</b> Bisagra regleta Ø 14 mm.

<b>5079</b> Manilla inox. recta	<b>5080</b> Manilla inox recta c/llave	<b>5086</b> Manilla inox recta acodada	<b>4613</b> Mecanismo Cuadrad. bidirec. practicable	<b>5081</b> Mecanismo Cuadrad. OS. BA.	<b>4727</b> Bisagra Flash Izquierda/Derecha	<b>4768</b> Bisagra 3º Hoja	<b>4769</b> Bisagra Extremo "Jirafa"	<b>4352</b> Bisagra ventana 3 hojas	<b>4389</b> Bisagra regleta Ø 16 mm.

<b>4724</b> Bisagra Os-Ba Simétrica 2º Hoja	<b>4739</b> Terminal pletina metálico	<b>4840</b> KIT Pasador hoja pasiva metál. (sup. e inf)	<b>4025</b> Kit Cremona EURO	<b>4010</b> Bisagra compás corto ralenti	<b>4085</b> Bisagra compás largo ralenti	<b>4846</b> Tercer punto de cierre

<b>4744</b> Bisagra Puerta 24,5 mm. Izda.	<b>4745</b> Bisagra Puerta 24,5 mm. Dcha.	<b>4079</b> Kit Cremona desmont. OS-Pa > 2000 mm.	<b>4365</b> Kit cremona desmont. OS-PA < 2000 mm.	<b>4002</b> Pasador oculto long. variable	<b>4003</b> Terminal de pletina cremona	<b>4007</b> Cierre complem. cre mona	<b>4011</b> Bisagra compás regul. proyectante	<b>4097</b> Escuadra acople pivotante

<b>4710</b> Escuadra alineamien. 14 mm.	<b>4735</b> Escuadra alineamien. 2 mm.	<b>4743</b> Escuadra intercalaria poliamida	<b>4765</b> Escuadra intercalaria poliamida	<b>4766</b> Escuadra intercalaria poliamida	<b>4767</b> Escuadra intercalaria poliamida

<b>5000</b> Escuadra Ap.Externa	<b>4708</b> Escuadra ángulo variable	<b>4039</b> Escuadra inox. alineamiento	<b>4304</b> Escuadra alineami. solapas	<b>4330</b> Escuadra alineamien. 15 mm.	<b>4855</b> Escuadra solapa 8893	<b>4009</b> Cierre cangrejo Interno	<b>4366</b> Cierre bisagra oculta	<b>4754</b> Retenedor de hoja

<b>4742</b> Escuadra alineamiento excéntrica	<b>4327</b> Escuadra Hoja balconera	<b>4326</b> Escuadra Cerco y Hoja	<b>4732</b> Escuadra Cerco balconera	<b>5002</b> Cierre suplem. entre hojas	<b>4720</b> Cerradero lateral doble pletina Zamak	<b>4842</b> Cerradero sup. regulable OS-BA

<b>4848</b> Microventilación practicable	<b>5026</b> Bulón regulable	<b>4005</b> Cerradero lateral pletina Nylon	<b>4004</b> Cerradero lateral doble pletina Nylon	<b>4078</b> Pieza sujeción junquillo curvo	<b>4391</b> Escuadra junquillos curvos	<b>4353</b> Kit acristalami. s/junquillo (2 A + 2 B)	<b>4356</b> Broca doble diámetro (s/junquillo)	<b>4035</b> Embellecedor salida agua

<b>4726</b> Taco Stilo pilastra 28 mm.	<b>4347</b> Taco Stilo pilastra ancha	<b>4343</b> Taco Stilo manguetón	<b>4713</b> Tapas acople ST-60 RPT-L	<b>4369</b> Junta central	<b>4055</b> Junta perim. hoja	<b>4337</b> Embelle. salida agua c/ membrana

<b>4088</b> Goma perimetral pivotante	<b>4370</b> Junta central "TC"	<b>4854</b> Escuadra vulcanizada	<b>4056</b> Junta perimetral hoja "TC"	<b>4397</b> Junta Stilo base rígida	<b>4379</b> Junta acústica cerco	<b>4303</b> Junta acústica cerco	<b>4741</b> Goma para batiente

<b>4089</b> Goma interior acrist. de 2 a 4 mm.	<b>4090</b> Goma interior acrist. de 4 a 6 mm.	<b>4091</b> Goma Interior acrist. de 6 a 8 mm.	<b>4057</b> Goma exterior acristalamiento	<b>4043</b> Juego tapas condensación	<b>5015</b> Plantilla escuadra ap.exterior RPT	<b>4760</b> Util manual escuadras intercalarias

### Accesorios Varios

- 4025 Kit Cremona EURO
- 4201 Kit Cremona Nova
- 4380 Kit Cremona EURO 2 hojas (sin cremona) 4002x2 + 4003x2 + 4025 + 4004x2 + 4008
- 4714 Kit Cremona EURO 1 hoja 4003x2 + 4025 + 4005x2
- 4300 Cerradura Balconera
- 4373 Cerradura, resbalón y palanca
- 4374 Cerradura seg. 3 puntos, pal. resbal.
- 4715 Cerradura Balconera E=25
- 4335 Ruleta para goma
- 4733 Fresa ST-60 RPT-L
- 4334 Tijeras ingleses goma
- 4393 Util manual (esc. 4097)
- 4062 Util Stilo abatibles
- 4841 Util multiple practicable
- 4845 Fresa Hoja Curva
- 5022 Cremona Industrial Prima
- 5023 Cremona Industrial Euro
- 5024 Herraje Os-Ba Industrial



# Perfiles

## Stilo - 60 RPT-L

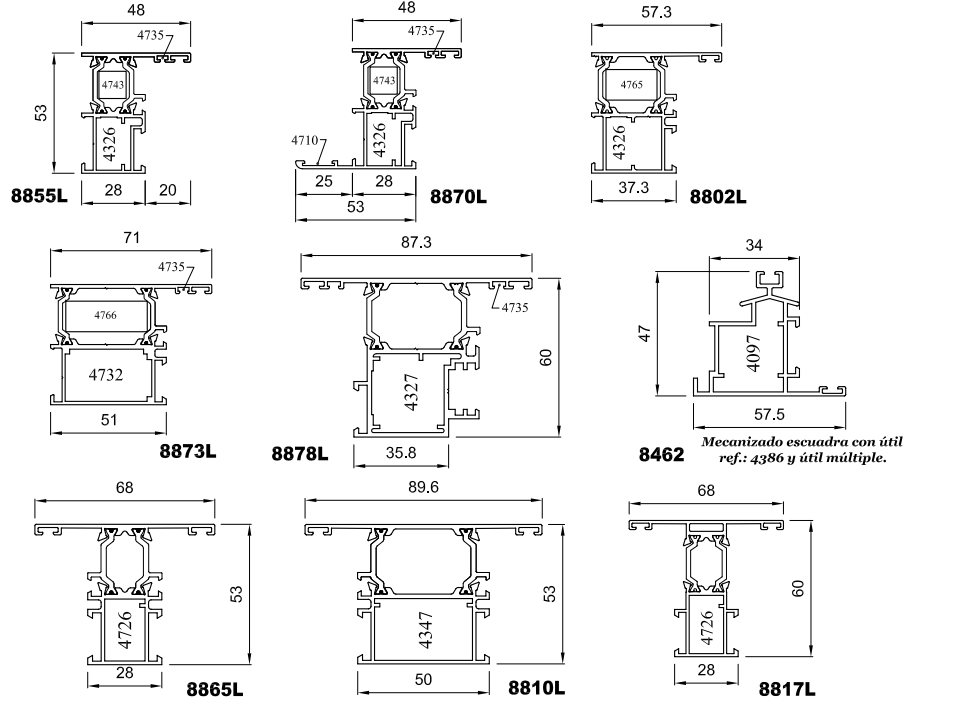

# Accesorios

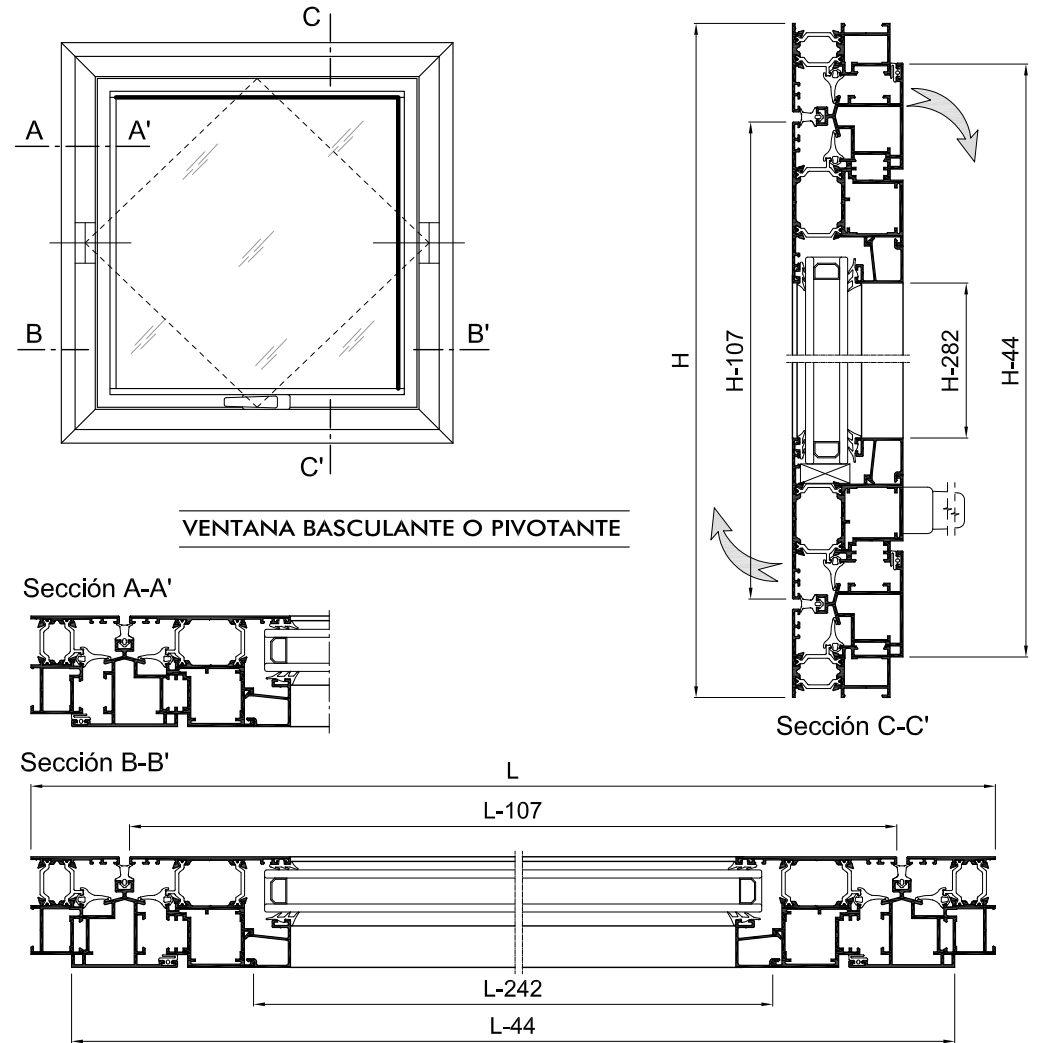

<b>RESISTENCIA</b>	<b>Pivotante HORIZONTAL</b>
	Peso máximo hoja : <b>120 Kg.</b>
	Dimensiones máximas (de hoja) altura : <b>2.200 mm.</b> anchura : <b>1.600 mm.</b>
	<b>Pivotante VERTICAL</b>
Peso máximo (por hoja) : <b>100 Kg.</b>	
Dimensiones máximas (de hoja) altura : <b>2.200 mm.</b> anchura : <b>1.600 mm.</b>	

- Accesorios Varios**
- 4062 Util Stilo abatibles
  - 4841 Util multiple practicable
  - 4071 Juego de fresas Stilo 53 mm.
  - 4072 Juego de fresas Stilo 63 mm.



# Perfiles

## Stilo - 60 RPT-L

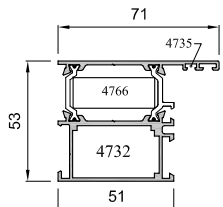

**8873L**

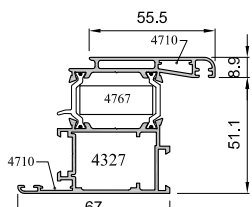

**8806L**

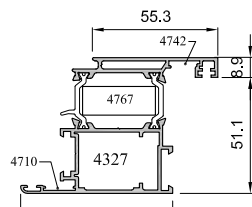

**8895L**

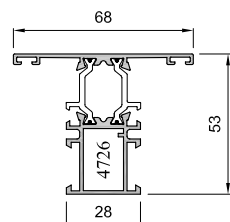

**8865L**

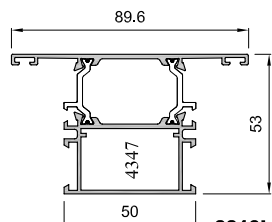

**8810L**

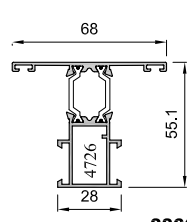

**8866L**

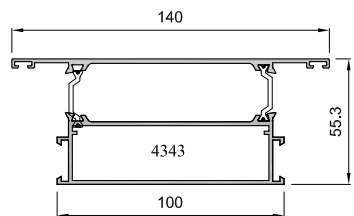

**8246L**

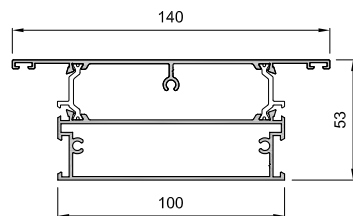

**8892L**

# Accesorios



**4326**  
Escuadra  
Cercos y Hoja



**4327**  
Escuadra  
Hoja balconera



**4732**  
Escuadra  
Cercos balconera

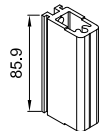

**4343**  
Taco Stilo  
manguetón



**4347**  
Taco Stilo  
pilastra ancha



**4726**  
Taco Stilo  
pilastra 28 mm



**4091**  
Goma interior  
acrist. de 6 a 8 mm.



**4090**  
Goma interior  
acrist. de 4 a 6 mm.



**4089**  
Goma interior  
acrist. de 2 a 4 mm.



**4057**  
Goma exterior  
acristamiento



**4369**  
Junta central



**4854**  
Escuadra vulcanizada



**4055**  
Junta  
perimetral  
hoja



**4056**  
Junta perimetral  
hoja "TC"



**4039**  
Escuadra inox.  
alineamiento



**4710**  
Escuadra alineamiento  
14 mm.



**4735**  
Escuadra alineamiento  
2 mm.



**4035**  
Embellecedor  
salida agua



**4337**  
Embellecedor  
salida agua c/membrana

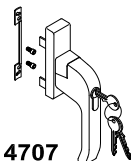

**4707**  
Cremona EURO  
c/llave

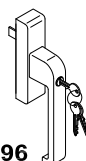

**4096**  
Cremona Os-Pa  
c/llave

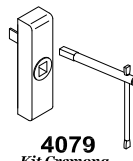

**4079**  
Kit Cremona  
desmontable Os-Pa  
mayor de 2000 mm.

CUADRADILLO 8 mm

HERRAJE OSCILO-PARALELA	
<b>4092</b>	Para long. de hoja de 700 a 900 mm.
<b>4093</b>	Para long. de hoja de 901 a 1100 mm.
<b>4094</b>	Para long. de hoja de 1101 a 1330 mm.
<b>4095</b>	Para long. de hoja de 1331 a 1650 mm.

	Mínimo	Máximo
Longitud de hoja	<b>700</b>	<b>1650</b>
Altura de hoja	<b>850</b>	<b>2400</b>
Peso máximo por hoja	<b>150 Kgs.</b>	

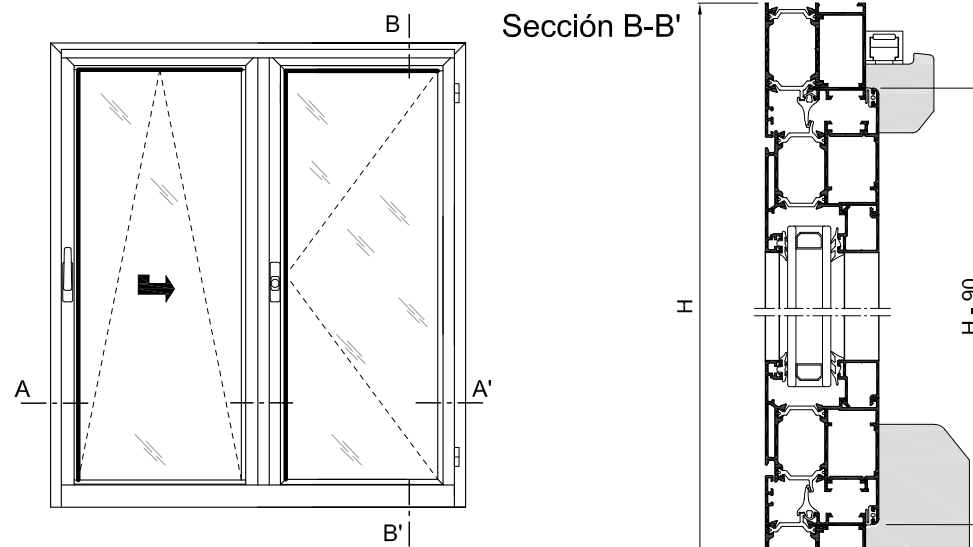

**PUERTA OSCILO PARALELA**

### Sección A-A'

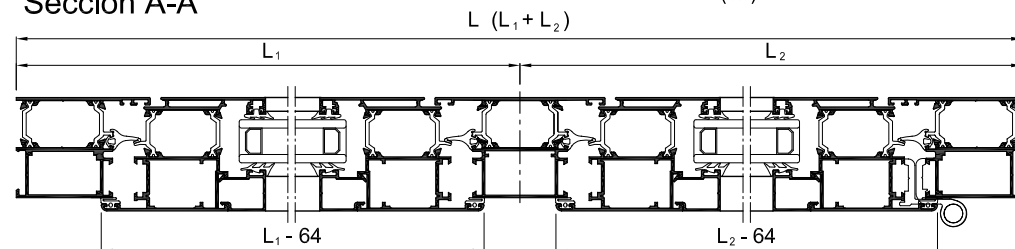

OBSERVACIONES : Para un buen funcionamiento de la Oscilo-Paralela se requiere un perfecto nivelado y aplomado en su colocación y apoyar mediante el calzo (\*) el carril en el suelo.

(\*) Calzo Carril

